

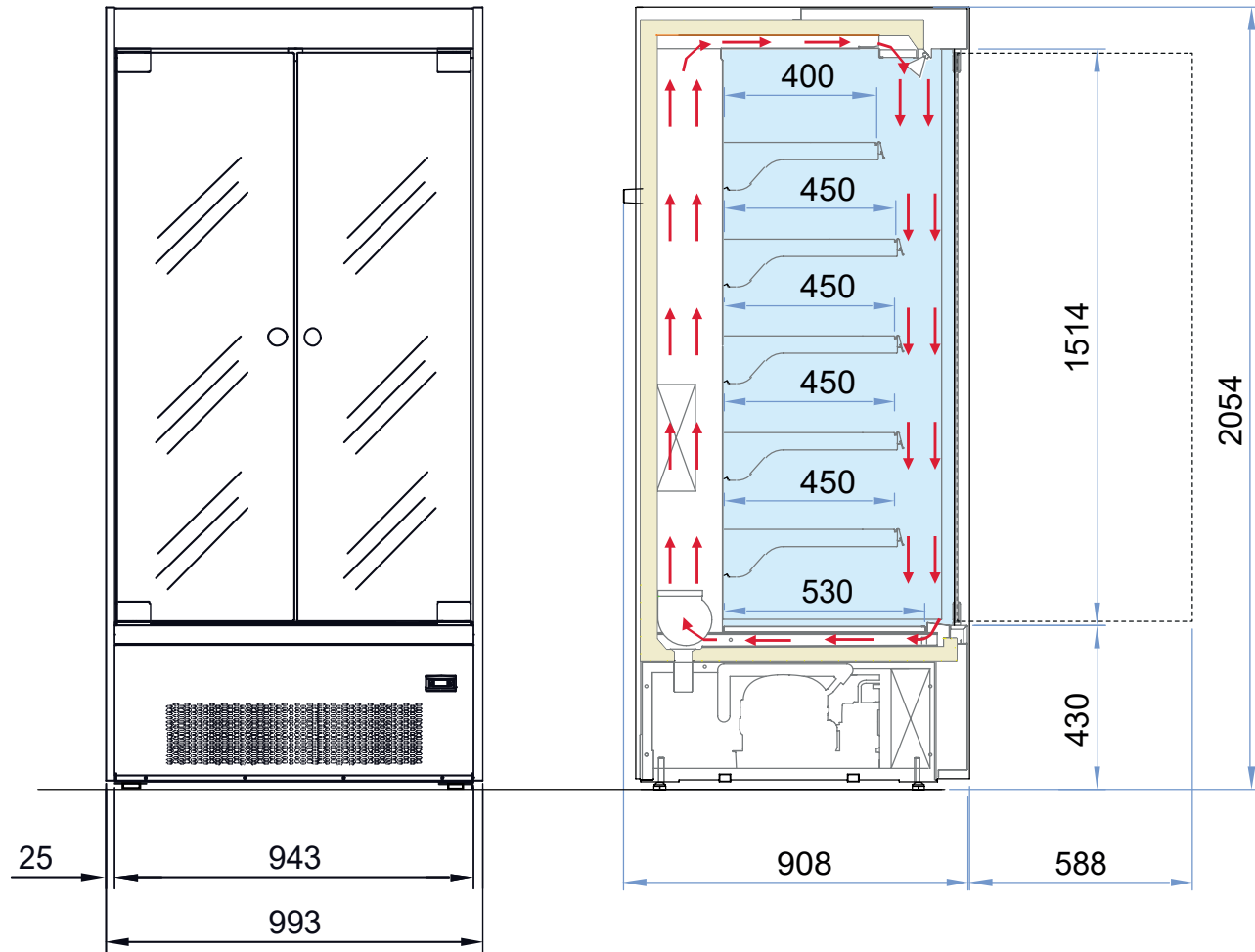

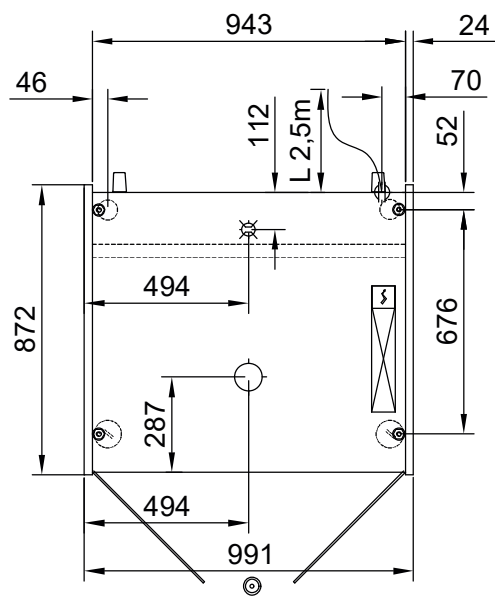







Masszeichnung Wandkühlregal GALAXY TN 940 SGD

[Artikel-Nr.: 4538051205094]





	STÜTZFUSS	 32
	ABFLUSS	Ø 25 mm
	GASANSCHLUSS	
	KABELAUSGANG	
	STEUERTRAFEL	
	RAD	
	RAD MIT BREMSE	
	KUNDENSEITE	
	ÖFFNUNG FÜR SCHLÄUCHE AM PODEST	