

# Schaltplan

## Eiswürfelbereiter SDH 40 L

[Art. 41330401063]

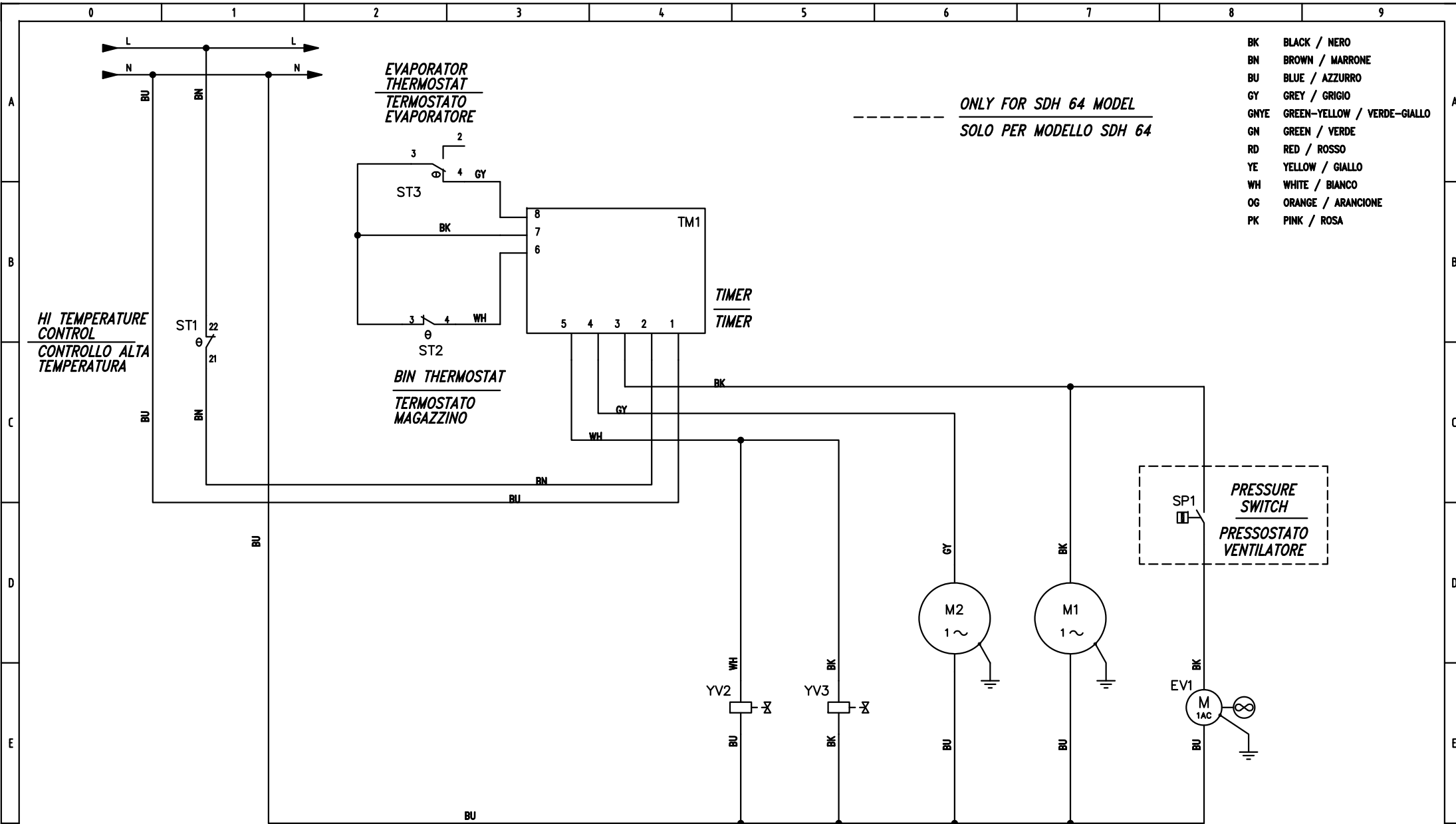



- BK BLACK / NERO
- BN BROWN / MARRONE
- BU BLUE / AZZURRO
- GY GREY / GRIGIO
- GNYE GREEN-YELLOW / VERDE-GIALLO
- GN GREEN / VERDE
- RD RED / ROSSO
- YE YELLOW / GIALLO
- WH WHITE / BIANCO
- OG ORANGE / ARANCIONE
- PK PINK / ROSA

----- ONLY FOR SDH 64 MODEL  
 SOLO PER MODELLO SDH 64

00 - EMISSIONE

00	18_224	LB	12.12.18		DATA	12.12.18
					DISEGN.	L.BOCA
					VISTO	G.ROMAGNOLI
REV.	MODIFICA	SG	DATA	FIRMA	APPR.	G.ROMAGNOLI

SCHEMA ELETTRICO  
 ELECTRICAL WIRING DIAGRAM











SDH 18/24/30/40/50/64



230 Vac 50/60 Hz

050578-03

=	=
+	+
00	FG. 2
	F.S. 4

Sim.\Sym	Sigla\Item	Funzione\Use Type	Sim.\Sym	Sigla\Item	Funzione\Use Type	Sim.\Sym	Sigla\Item	Funzione\Use Type
	EV1	Fan motor Ventilatore						
	M1	Compressor Compressore						
	M2	Water pump Pompa acqua						
	ST1	HI Temperature control Controllo alta temperatura						
	ST2	Bin thermostat Termostato magazzino						
	ST3	Evaporator thermostat Termostato evaporatore						
	TM1	Electronic timer Timer elettronico						
	YV2	Water inlet valve Elettrovalvola ingresso acqua						
	YV3	Hot gas valve Elettrovalvola gas caldo						
	SP1	Fan pressure switch Pressostato ventilatore						

00 - EMISSIONE

00	18_224	LB	12.12.18		DATA	12.12.18	LEGENDA SIMBOLI SYMBOLS LEGEND			SDH 18/24/30/40/50/64	 Ice Systems	230 Vac 50/60 Hz		= =	
					DISEGN.	L.BOGA						+			
					VISTO	G.ROMAGNOLI									
REV.	MODIFICA	SG	DATA	FIRMA	APPR.	G.ROMAGNOLI	SOST. IL :	12.12.18	SOST. DA :	G.ROMAGNOLI	FILE :	05057830.DWG	050578-03	00	FG. 3 F.S. 4

**Finanzen/Service**

**28307 Bremen**

Thalenhorststraße 15  
Tel.+49 421 48557-0  
Fax+49 421 488650  
bremen@nordcap.de

**Vertrieb Ost**

**12681 Berlin**

Wolfener Straße 32/34, Haus K  
Tel.+49 30 936684-0  
Fax+49 30 936684-44  
berlin@nordcap.de

**Vertrieb West**

**40699 Erkrath**

Max-Planck-Straße 30  
Tel.+49 211 540054-0  
Fax+49 211 540054-54  
erkrath@nordcap.de

**Vertrieb Nord**

**21079 Hamburg**

Großmoorbogen 5  
Tel.+49 40 766183-0  
Fax+49 40 770799  
hamburg@nordcap.de

**Vertrieb Süd**

**55218 Ingelheim**

Hermann-Bopp-Straße 4  
Tel.+49 6132 7101-0  
Fax+49 6132 7101-20  
ingelheim@nordcap.de



[www.nordcap.de](http://www.nordcap.de)