

Schaltplan

Elektroherd **EH7 / 2RPT**

[Artikel-Nr.: 406372014]

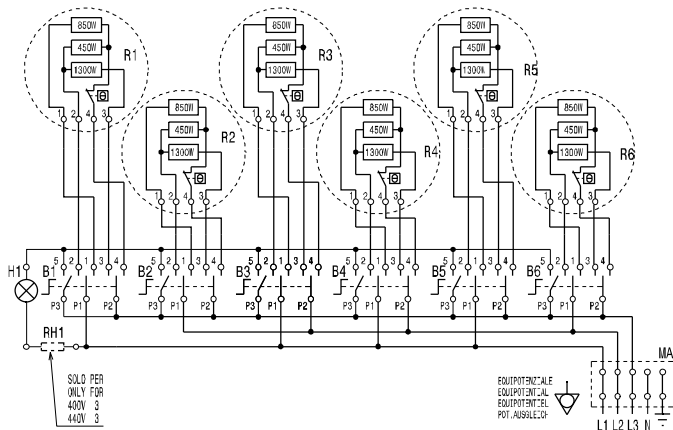



400V - 3/3N 50/60Hz
15.6KW 22.5A

230V - 3 50/60Hz
15.6KW 40A

440V - 3 50/60Hz
15.6KW 20.5A

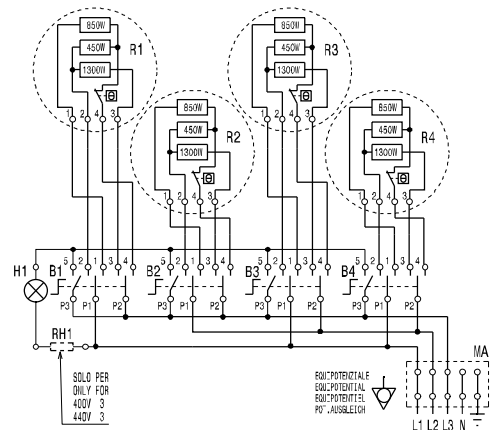

400V - 3/3N 50/60Hz
10.4KW 17.5A

230V - 3 50/60Hz
10.4KW 30A

440V - 3 50/60Hz
10.4KW 16A

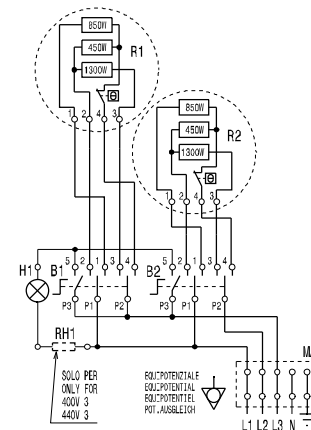

400V - 3/3N 50/60Hz
5.2KW 11.5A

230V - 3 50/60Hz
5.2KW 20A

440V - 3 50/60Hz
5.2KW 10.5A

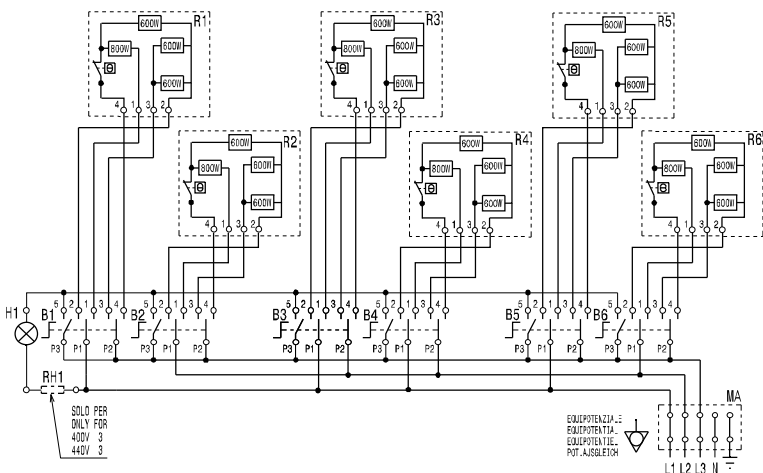

400V - 3/3N 50/60Hz
15.6KW 22.5A

230V - 3 50/60Hz
15.6KW 40A

440V - 3 50/60Hz
15.6KW 20.5A

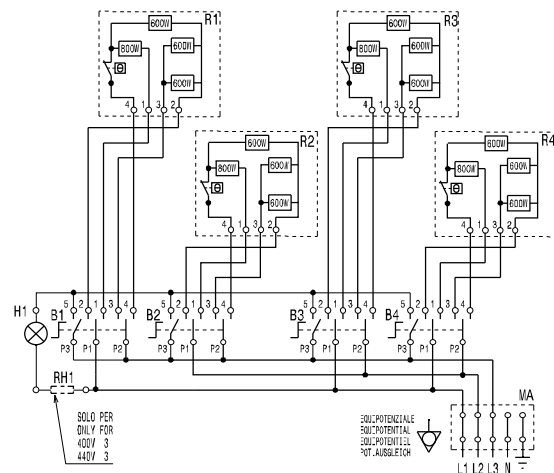

400V - 3/3N 50/60Hz
10.4KW 17.5A

230V - 3 50/60Hz
10.4KW 30A

440V - 3 50/60Hz
10.4KW 16A

B1-6

POSITION	5	2	1	3	4	POWER (W)
0						0
6	●	●	●	●	●	2600
5	●	●	●	●	●	1800
4	●	●	●	●	●	1200
3	●	●	●	●	●	600
2	●	●	●	●	●	400
1	●	●	●	●	●	265

RH1	RESISTENZA LAMPADA	RESISTANCE FOR LAMP
R1-R6	PIASTRE RISCALDANTI	HOTPLATES
H1	LAMPADA	LAMP
B1-B6	COMMUTATORE PIASTRE	HOTPLATES ROTARY SWITCH
MA	MORSETTIERA DI ALLACCIAMENTO	MAIN TERMINAL BOARD

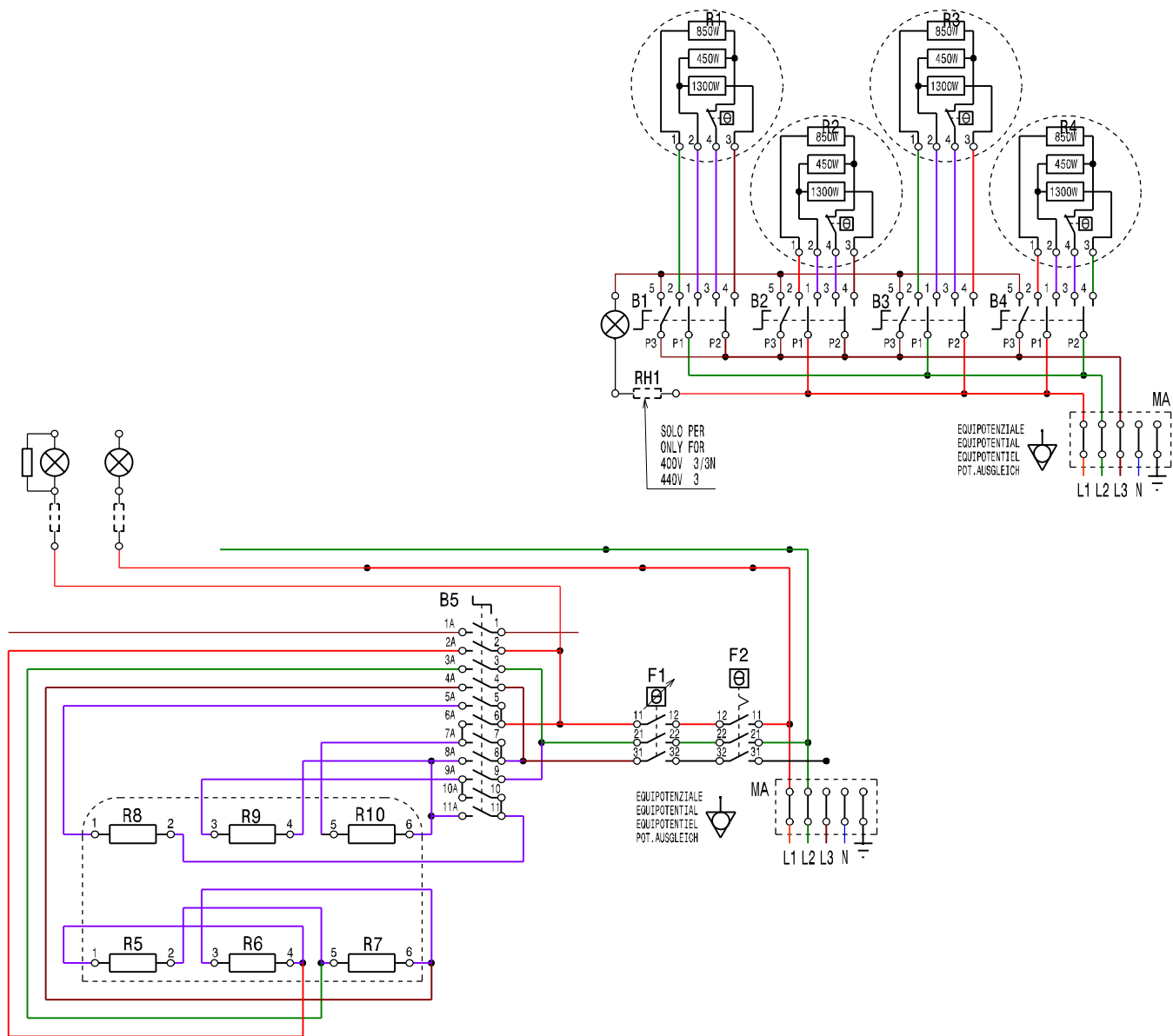

Finanzen/Service

28307 Bremen
Thalenhorststraße 15
Tel.+49 421 48557-0
Fax+49 421 488650
bremen@nordcap.de

Vertrieb Ost

12681 Berlin
Wolfener Straße 32/34, Haus K
Tel.+49 30 936684-0
Fax+49 30 936684-44
berlin@nordcap.de

Vertrieb West

40699 Erkrath
Max-Planck-Straße 30
Tel.+49 211 540054-0
Fax+49 211 540054-54
erkrath@nordcap.de

Vertrieb Nord

21079 Hamburg
Großmoorbogen 5
Tel.+49 40 766183-0
Fax+49 40 770799
hamburg@nordcap.de

Vertrieb Süd

55218 Ingelheim
Hermann-Bopp-Straße 4
Tel.+49 6132 7101-0
Fax+49 6132 7101-20
ingelheim@nordcap.de



www.nordcap.de