

Schaltplan

Geschirrspülmaschine **ZLAI3WG**

[Art. 406502731]

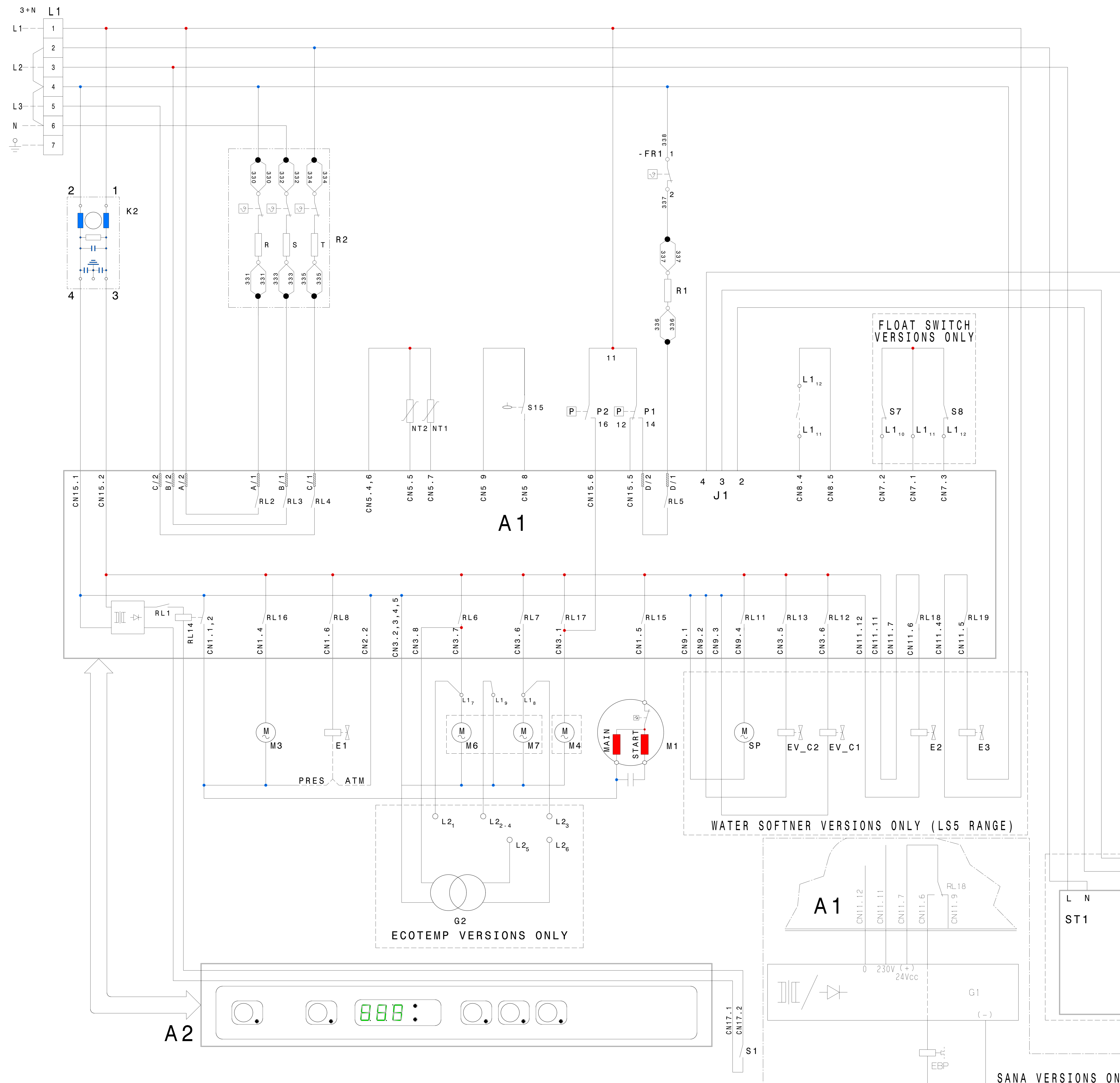



- A1 MAIN BOARD
- A2 USER INTERFACE
- A3 WATER SOFTENER ELECTRICAL BOARD
- C1 WASH PUMP CONTACTOR
- CP WASH PUMP CONNECTOR
- E1 WATER LOAD SOLENOID VALVE
- E2 BRINE SOLENOID VALVE
- E3 RESIN WASH SOLENOID VALVE
- E5 SALT CONTAINER SOLENOID VALVE
- E6-E7-E8-E9 WATER SOFTENER SOLENOID VALVES
- EBP DOOR LOCK DEVICE
- EV_C1/EV_C2 LOW PRESSURE SOLENOID VALVES
- FR1 PROTECTION TANK HEATING ELEMENT
- G1 DC POWER SUPPLY
- K1 R.F.I. FILTERS
- L1 TERMINAL BLOCK
- L1/7-9 DETERGENT DISPENSER CONNECTING TERMINALS
- L1/8-9 RINSE AID DISPENSER CONNECTING TERMINALS
- L1/11-12 ENERGY PEAK CONTROLLER TERMINALS
- L2 AUXILIARY TERMINAL BLOCK
- L3 HACCP CONNECTION
- M1 WASH PUMP
- M3 RINSE PUMP
- M4 DRAIN PUMP
- M6 DETERGENT DISPENSER
- M7 RINSE AID DISPENSER
- NT1 NTC - TANK TEMPERATURE SENSOR
- NT2 NTC - BOILER TEMPERATURE SENSOR
- NT3 WATER SOFTENER TEMPERATURE SENSOR
- P1,2 PRESSURE SWITCH
P1: TANK LEVEL
P2: OVERFLOW
- R1 TANK HEATING ELEMENT
- R2 BOILER HEATING ELEMENT
- S1 DOOR SWITCH
- S7 DETERGENT FLOAT SWITCH
- S8 RINSE AID FLOAT SWITCH
- S9 FLOWMETER
- S10-S11-S12-S13-S14 WATER SOFTENER CONDUCTIVITY SENSORS
- S15 BOILER LEVEL SENSOR
- S16 REGENERATION LEVEL SENSOR
- SFC-6 FERRITE
- SFC-10 FERRITE
- SP SALT RECEPTACLE DRAIN PUMP

This drawing contains confidential information and is the property of
 ELECTROLUX PROFESSIONAL, Valmadrera (Lecco), Italy, without whose permission
 it is not to be reproduced, copied, or transmitted in any form or by any means
 and it is to be returned to the originator immediately after use.
 PROFESSIONAL, Valmadrera (Lecco), Italy, which is responsible for the drawing.

PTEGA SU 650 UP PTEGA GIU PTEGA DOWN PTEGA DOWN
 SUPERFICIO IN VISTA VISIBILE SUPERFICIE

RoHS 2011/65/EU

TI COMPONENTE DEBE ESSERE CONFORME ALLA DIRETTIVA COMPLIANT TO STANDARDS

WATER SOFTENER VERSIONS ONLY (LS6 - WT30 RANGE)

A3

L N 5 4 3
ST1 ST8
1 ST5 3

E5

| | | | |
|--------------------------------------------------------------|-----------------------------|-----------------------------------------------------|-----------------|
| D 107 MODIFICA CONNESSIONE CAVO DI TERRA ALLA USER A2 | RADI L. BARBIERI 19/01/2009 | PROCALE | DATE 26/05/2015 |
| C 061 INSERITO VALVOLA PER PROTEZIONE RESISTENZA VASCA | RADI L. BARBIERI 26/05/2015 | | |
| 051 TUBO FILTRO TRIFASE KI | RADI F. MORETTO 11/04/2015 | ORNI L. Barbieri | |
| 054 MODIFICATI CONNETTORI PER LE CONNESSIONI ALLE RESISTENZE | RADI F. MORETTO 12/12/2010 | ORNI | |
| 053 MODIFICATI CONNETTORI PER LE CONNESSIONI ALLA | RADI L. BARBIERI 04/12/2008 | ORNI | |
| RESISTENZA VASCA DA TARGA A CERBIE | | | |
| MODIFICAZIONI | REG. 515m | DATE | APP. G. Moretto |
| MATERIALI: | | | |
| TREATMENT: | | | |
| SUPPLY SPECIFICATIONS N° | | | |
| DERIVED FROM N° | | | |
| REPLACES N° | | | |
| ESSENTE DA NAVIGARE E SPICILANTE I RAGLI LENTE | | | |
| FREE OF BURRS AND CUTTING EDGES | | | |
| | | DESCRIPTION SCHEMA ELETTRICO LS5-LS6 DASHWASHING | |
| | | PART N° 600625807 REV D | |

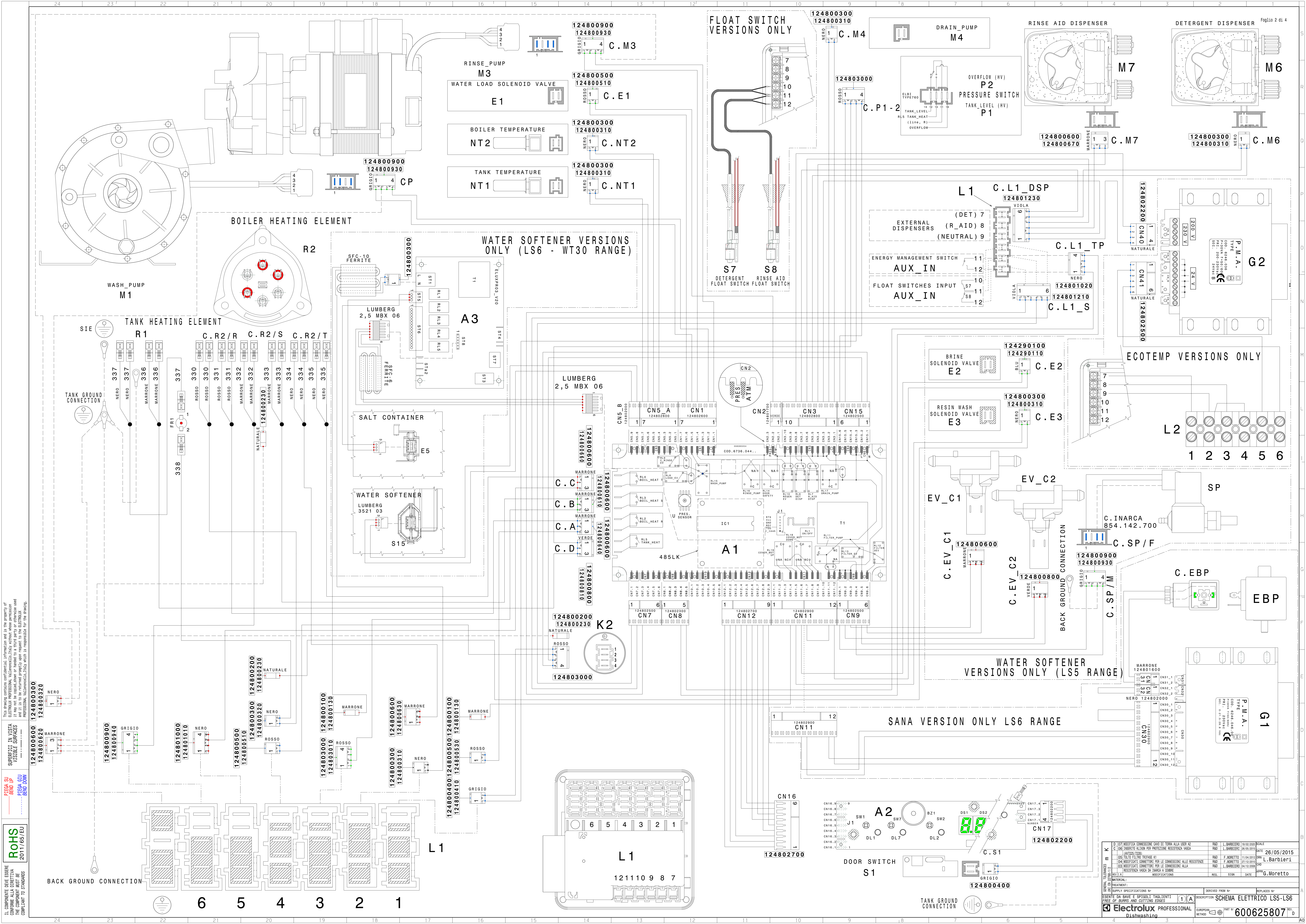

TI COMPONETE DEVE ESSERE CONFORME ALLA DIRETTIVA ROHS 2011/65/EU
 COMPLIANT TO STANDARDS
 PLSA SU 650 UP PLSA GIU 650 DOWN
 SUPERFICIO IN VISTA VISIBILE SOPRANCE
 ELETTRICI PROFESSIONAL, VALMORCOTTA, ITALY
 ELETTRICI PROFESSIONAL, VALMORCOTTA, ITALY
 ELETTRICI PROFESSIONAL, VALMORCOTTA, ITALY
 ELETTRICI PROFESSIONAL, VALMORCOTTA, ITALY
 ELETTRICI PROFESSIONAL, VALMORCOTTA, ITALY

| REV. | DESCRIPTION | DATE | APPR. |
|------|-------------------------------------------------|------------|------------|
| K | MODIFICA CONNESSIONE CABO DI TERRA ALLA USER A2 | 26/05/2015 | L.Barbieri |
| C | MODIFICA CONNESSIONE CABO DI TERRA ALLA USER A2 | 26/05/2015 | L.Barbieri |
| J | MODIFICA CONNESSIONE CABO DI TERRA ALLA USER A2 | 26/05/2015 | L.Barbieri |
| I | MODIFICA CONNESSIONE CABO DI TERRA ALLA USER A2 | 26/05/2015 | L.Barbieri |
| H | MODIFICA CONNESSIONE CABO DI TERRA ALLA USER A2 | 26/05/2015 | L.Barbieri |
| G | MODIFICA CONNESSIONE CABO DI TERRA ALLA USER A2 | 26/05/2015 | L.Barbieri |
| F | MODIFICA CONNESSIONE CABO DI TERRA ALLA USER A2 | 26/05/2015 | L.Barbieri |
| E | MODIFICA CONNESSIONE CABO DI TERRA ALLA USER A2 | 26/05/2015 | L.Barbieri |
| D | MODIFICA CONNESSIONE CABO DI TERRA ALLA USER A2 | 26/05/2015 | L.Barbieri |
| C | MODIFICA CONNESSIONE CABO DI TERRA ALLA USER A2 | 26/05/2015 | L.Barbieri |
| B | MODIFICA CONNESSIONE CABO DI TERRA ALLA USER A2 | 26/05/2015 | L.Barbieri |
| A | MODIFICA CONNESSIONE CABO DI TERRA ALLA USER A2 | 26/05/2015 | L.Barbieri |

Electrolux PROFESSIONAL
 Disheswashing
 600625807

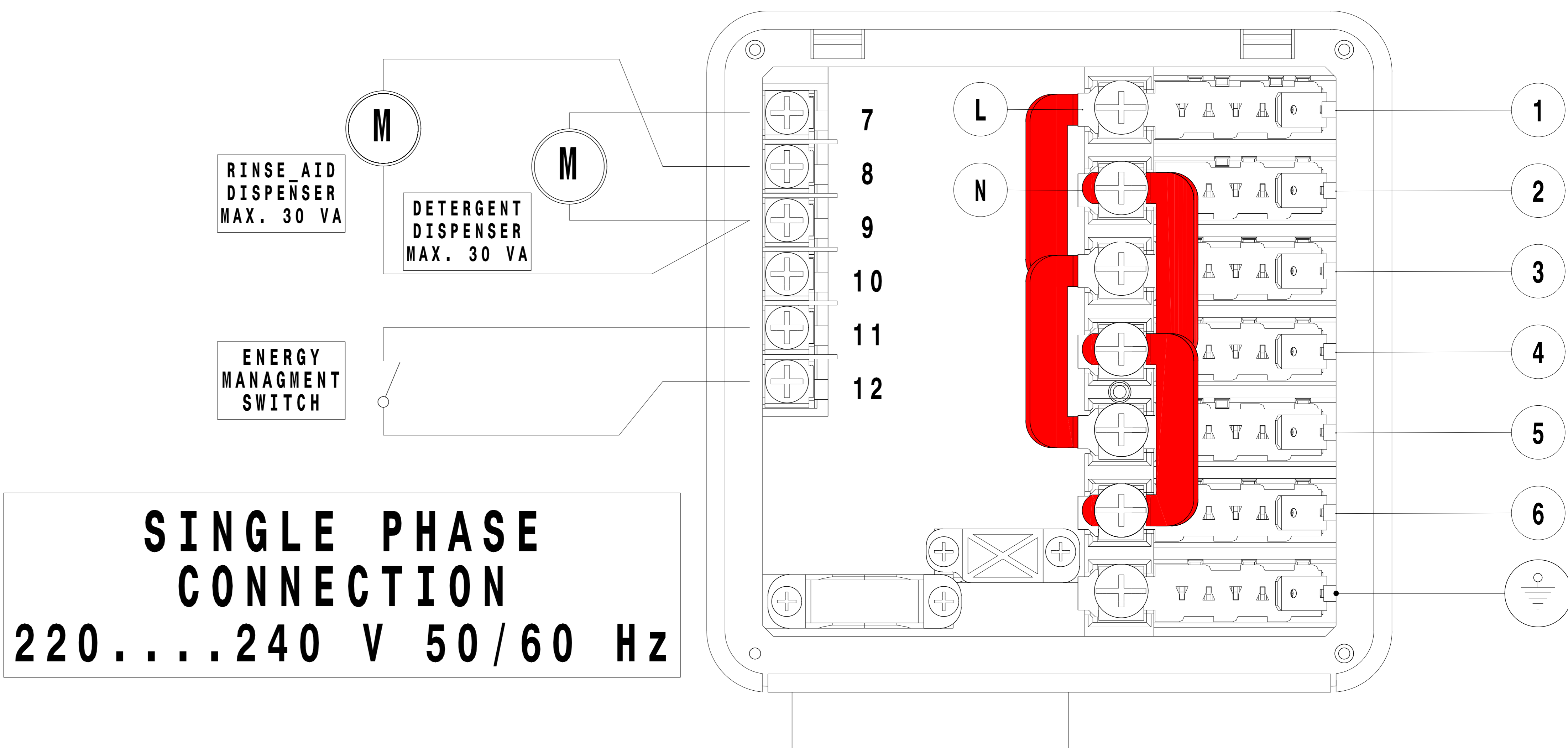
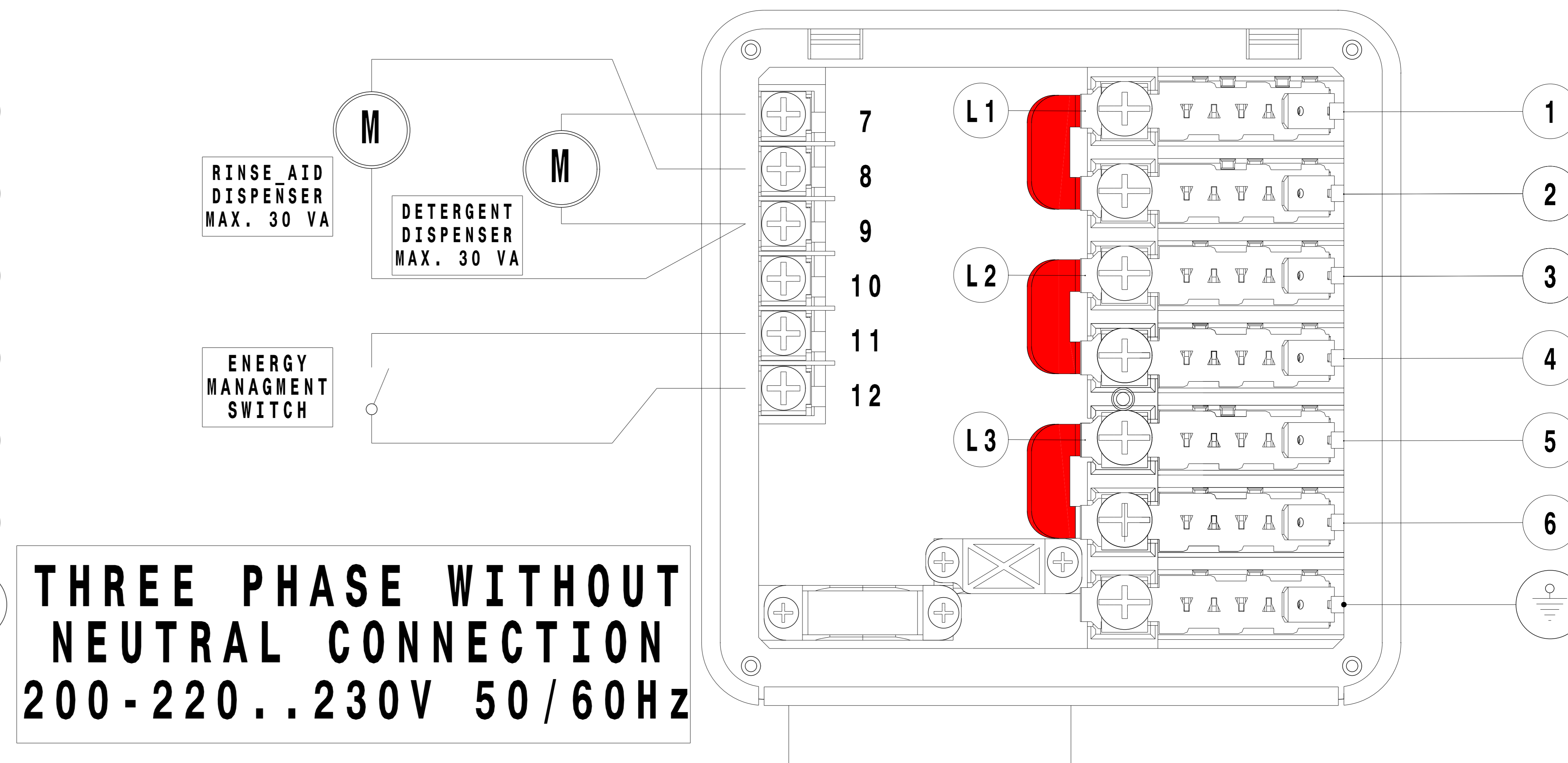
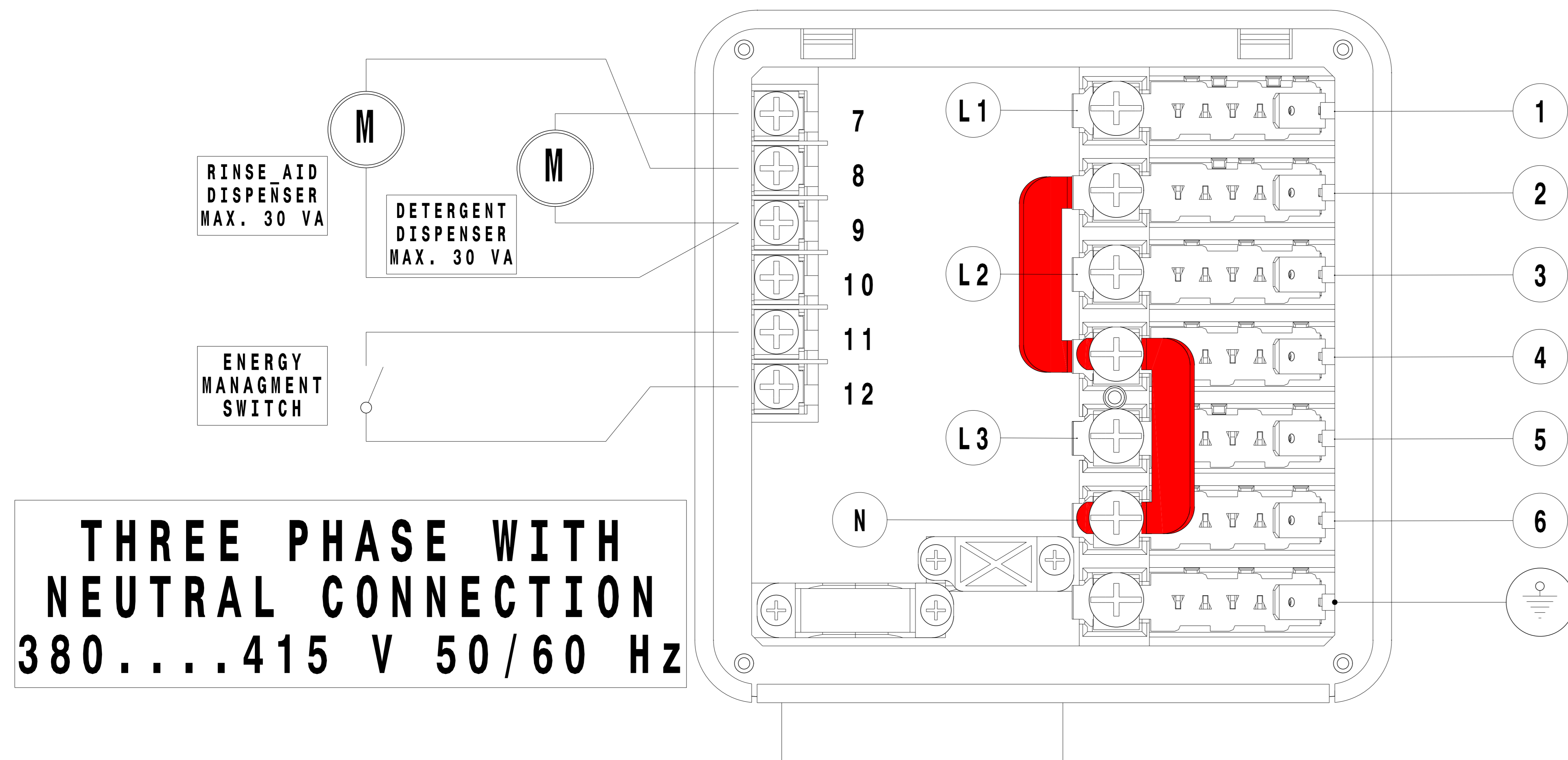

This drawing contains confidential information and is the property of
 ELECTROLUX PROFESSIONAL, Valmonastero, Italy, without whose permission
 it is not to be reproduced, stored in a retrieval system or used
 in any form or by any means, electronic, mechanical, photocopying,
 recording, scanning, copying, or otherwise, and it is to be returned to the
 PROFESSIONAL, Valmonastero, Italy which is responsible for the drawing.

SUPERFICIO IN VISTA
 VISIBILE SURFACES

PTEGA SU
 BEND UP PTEGA GIU
 BEND DOWN

RoHS
 2011/65/EU

IL COMPONENTE DEVE ESSERE
 CONFORME ALLA DIRETTIVA
 THE COMPONENT MUST BE
 COMPLIANT TO STANDARDS

| | | | | |
|--------------------------------------------------------------------------------------------------------------------------------------------------------------------------------------------------------------------------------------------------------------------------------------------------------------------------------------------------------------------------------------------------------------------------------------------------------------------------------------------------------------------------------------------------------------------------------------------------------------------------------------------------------------------------------------------------------------------------------------------------------------------------------------------------------------------------------------------------------------------------------------------------------------------------------------------------------------------------------------------------------------------------------------------------------------------------------------------------------------------------------------------------------------------------------------------------------------------------------------------------------------------------------------------------------------------------------------------------------------------------------------------------------------------------------------------------------------------------------------------------------------------------------------------------------------------------------------------------------------------------------------------------------------------------------------------------------------------------------------------------------------------------------------------------------------------------------------------------------------------------------------------------------------------------------------------------------------------------------------------------------------------------------------------------------------------------------------------------------------------------------------------------------------------------------------------------------------------------------------------------------------------------------------------------------------------------------------------------------------------------------------------------------------------------------------------------------------------------------------------------------------------------------------------------------------------------------------------------------------------------------------------------------------------------------------------------------------------------------------------------------------------------------------------------------------------------------------------------------------------------------------------------------------------------------------------------------------------------------------------------------------------------------------------------------------------------------------------------------------------------------------------------------------------------------------------------------------------------------------------------------------------------------------------------------------------------------------------------------------------------------------------------------------------------------------------------------------------------------------------------------------------------------------------------------------------------------------------------------------------------------------------------------------------------------------------------------------------------------------------------------------------------------------------------------------------------------------------------------------------------------------------------------------------------------------------------------------------------------------------------------------------------------------------------------------------------------------------------------------------------------------------------------------------------------------------------------------------------------------------|---------------------------------------------------------------------------------------------------------------------------------------------------------------------------------------------------------------------------------------------------------------------------------------------------------------------------------------------|-------------------------------------------------------------------------------------------------------------------------------------------------------------------------------------|-----------------------------------------------------------------------------------------------------------------------------------------------------------|-------|
| K M N P Q R S T U V W X Y Z AA AB AC AD AE AF AG AH AI AJ AK AL AM AN AO AP AQ AR AS AT AU AV AW AX AY AZ BA BB BC BD BE BF BG BH BI BJ BK BL BM BN BO BP BQ BR BS BT BU BV BW BX BY BZ CA CB CC CD CE CF CG CH CI CJ CK CL CM CN CO CP CQ CR CS CT CU CV CW CX CY CZ DA DB DC DD DE DF DG DH DI DJ DK DL DM DN DO DP DQ DR DS DT DU DV DW DX DY DZ EA EB EC ED EE EF EG EH EI EJ EK EL EM EN EO EP EQ ER ES ET EU EV EW EX EY EZ FA FB FC FD FE FF FG FH FI FJ FK FL FM FN FO FP FQ FR FS FT FU FV FW FX FY FZ GA GB GC GD GE GF GG GH GI GJ GK GL GM GN GO GP GQ GR GS GT GU GV GW GX GY GZ HA HB HC HD HE HF HG HH HI HJ HK HL HM HN HO HP HQ HR HS HT HU HV HW HX HY HZ IA IB IC ID IE IF IG IH II IJ IK IL IM IN IO IP IQ IR IS IT IU IV IW IX IY IZ JA JB JC JD JE JF JG JH JI JJ JK JL JM JN JO JP JQ JR JS JT JU JV JW JX JY JZ KA KB KC KD KE KF KG KH KI KJ KK KL KM KN KO KP KQ KR KS KT KU KV KW KX KY KZ LA LB LC LD LE LF LG LH LI LJ LK LL LM LN LO LP LQ LR LS LT LU LV LW LX LY LZ MA MB MC MD ME MF MG MH MI MJ MK ML MN MO MP MQ MR MS MT MU MV MW MX MY MZ NA NB NC ND NE NF NG NH NI NJ NK NL NM NO NP NQ NR NS NT NU NV NW NX NY NZ OA OB OC OD OE OF OG OH OI OJ OK OL OM ON OO OP OQ OR OS OT OU OV OW OX OY OZ PA PB PC PD PE PF PG PH PI PJ PK PL PM PN PO PP PQ PR PS PT PU PV PW PX PY PZ QA QB QC QD QE QF QG QH QI QJ QK QL QM QN QO QP QQ QR QS QT QU QV QW QX QY QZ RA RB RC RD RE RF RG RH RI RJ RK RL RM RN RO RP RQ RR RS RT RU RV RW RX RY RZ SA SB SC SD SE SF SG SH SI SJ SK SL SM SN SO SP SQ SR SS ST SU SV SW SX SY SZ TA TB TC TD TE TF TG TH TI TJ TK TL TM TN TO TP TQ TR TS TU TV TW TX TY TZ UA UB UC UD UE UF UG UH UI UJ UK UL UM UN UO UP UQ UR US UT UY UZ VA VB VC VD VE VF VG VH VI VJ VK VL VM VN VO VP VQ VR VS VT VU VV VW VX VY VZ WA WB WC WD WE WF WG WH WI WJ WK WL WM WN WO WP WQ WR WS WT WU WV WW WX WY WZ XA XB XC XD XE XF XG XH XI XJ XK XL XM XN XO XP XQ XR XS XT XU XV XW XX XY XZ YA YB YC YD YE YF YG YH YI YJ YK YL YM YN YO YP YQ YR YS YT YU YV YW YX YZ ZA ZB ZC ZD ZE ZF ZG ZH ZI ZJ ZK ZL ZM ZN ZO ZP ZQ ZR ZS ZT ZU ZV ZW ZX ZY ZZ | D 107 MODIFICA CONNESSIONE CAVO DI TERRA ALLA USER A2 C 061 INSERITO VILJON PER PROTEZIONE RESISTENZA VASCA (AVVIZIO/NOTE) OS1 TOLTO FILTRO TRIFASE KI OS4 MODIFICATI CONNETTORI PER LE CONNESSIONI ALLE RESISTENZE OS5 MODIFICATI CONNETTORI PER LE CONNESSIONI ALLA RESISTENZA VASCA DA TARGA A CERBIE MODIFICAZIONI | RAO L. BARBIERI 19/10/2010 RAO L. BARBIERI 26/05/2015 RAO F. MORETTO 11/10/2015 RAO F. MORETTO 07/10/2010 RAO L. BARBIERI 04/12/2009 REG. 0109 DATE APPR. G. Moretto | RAO L. BARBIERI 19/10/2010 DATE 26/05/2015 RAO F. MORETTO 11/10/2015 RAO F. MORETTO 07/10/2010 RAO L. BARBIERI 04/12/2009 APPR. G. Moretto | |
| | MATERIAL: TREATMENT: SUPPLY SPECIFICATIONS N° DERIVED FROM N° REPLACES N° | DESCRIPTION SCHEMA ELETTRICO L55-L56 EUROPEAN METHOD 1 A | PART N° 600625807 | REV D |
| | ESSENTE DA NAVIGARE E SPERIMENTARE FREE OF BURNS AND CUTTING EDGES | 1 A | 600625807 | REV D |
| | Electrolux PROFESSIONAL Dishwashing | 1 A | 600625807 | REV D |

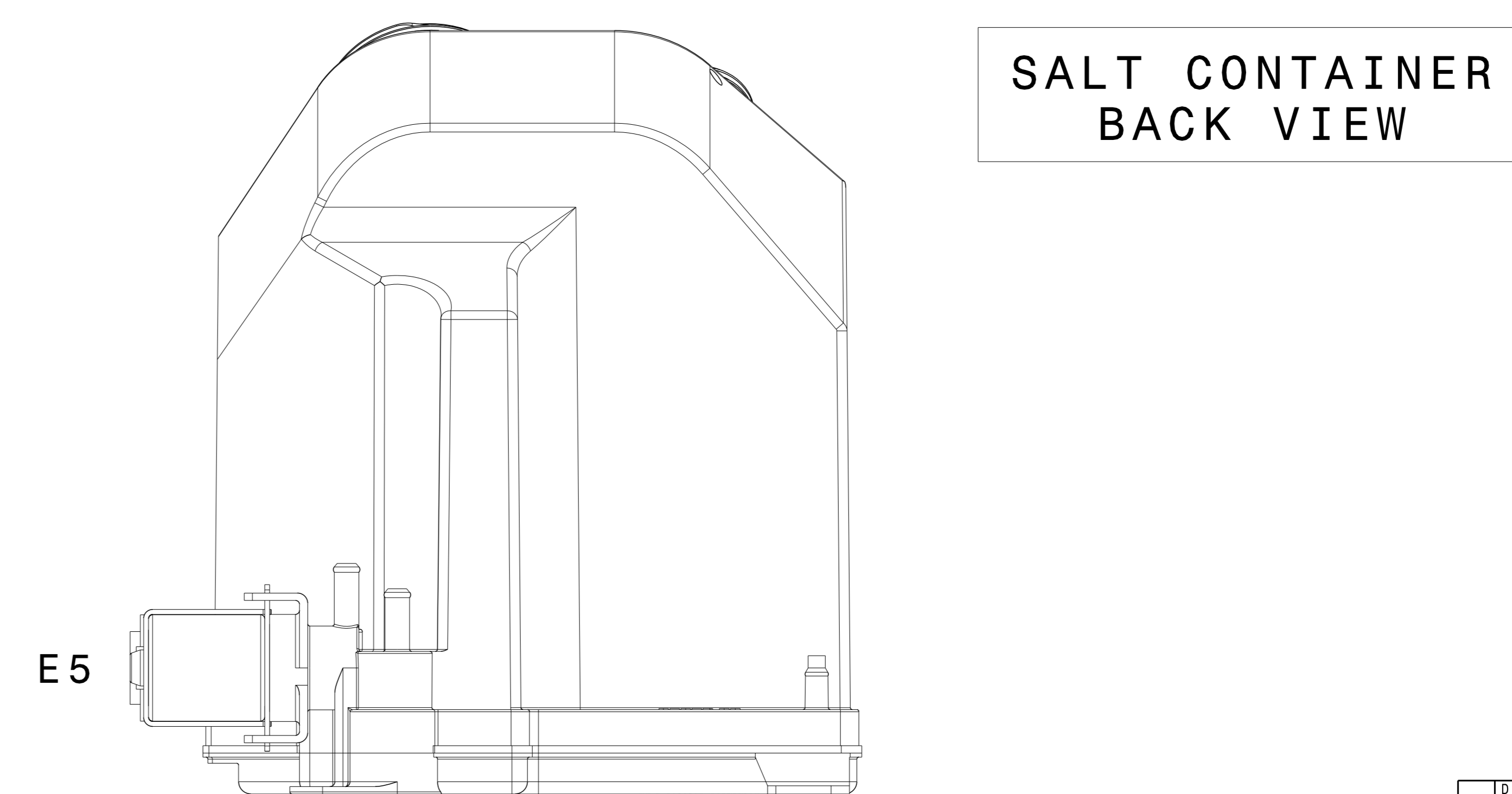
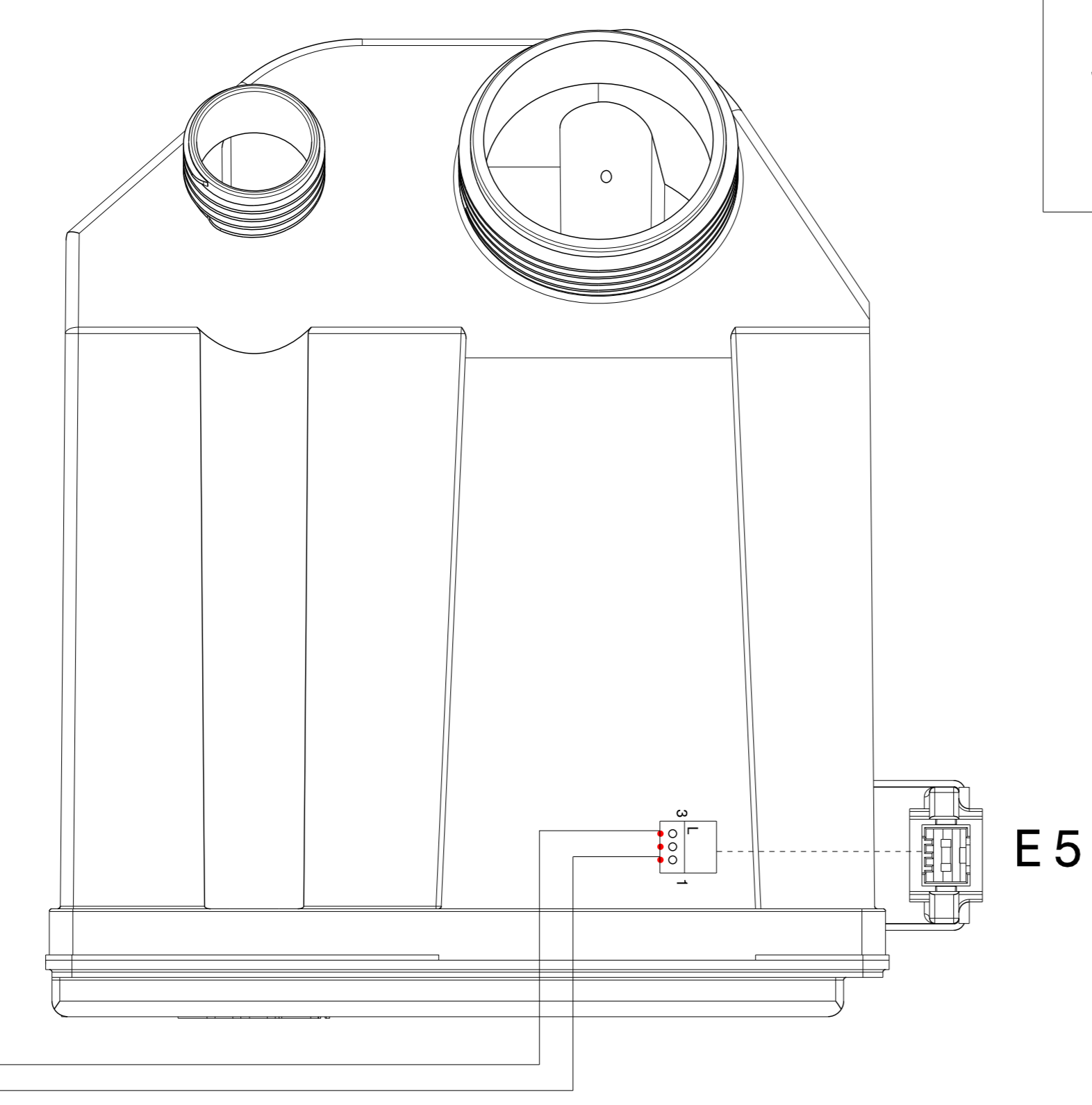
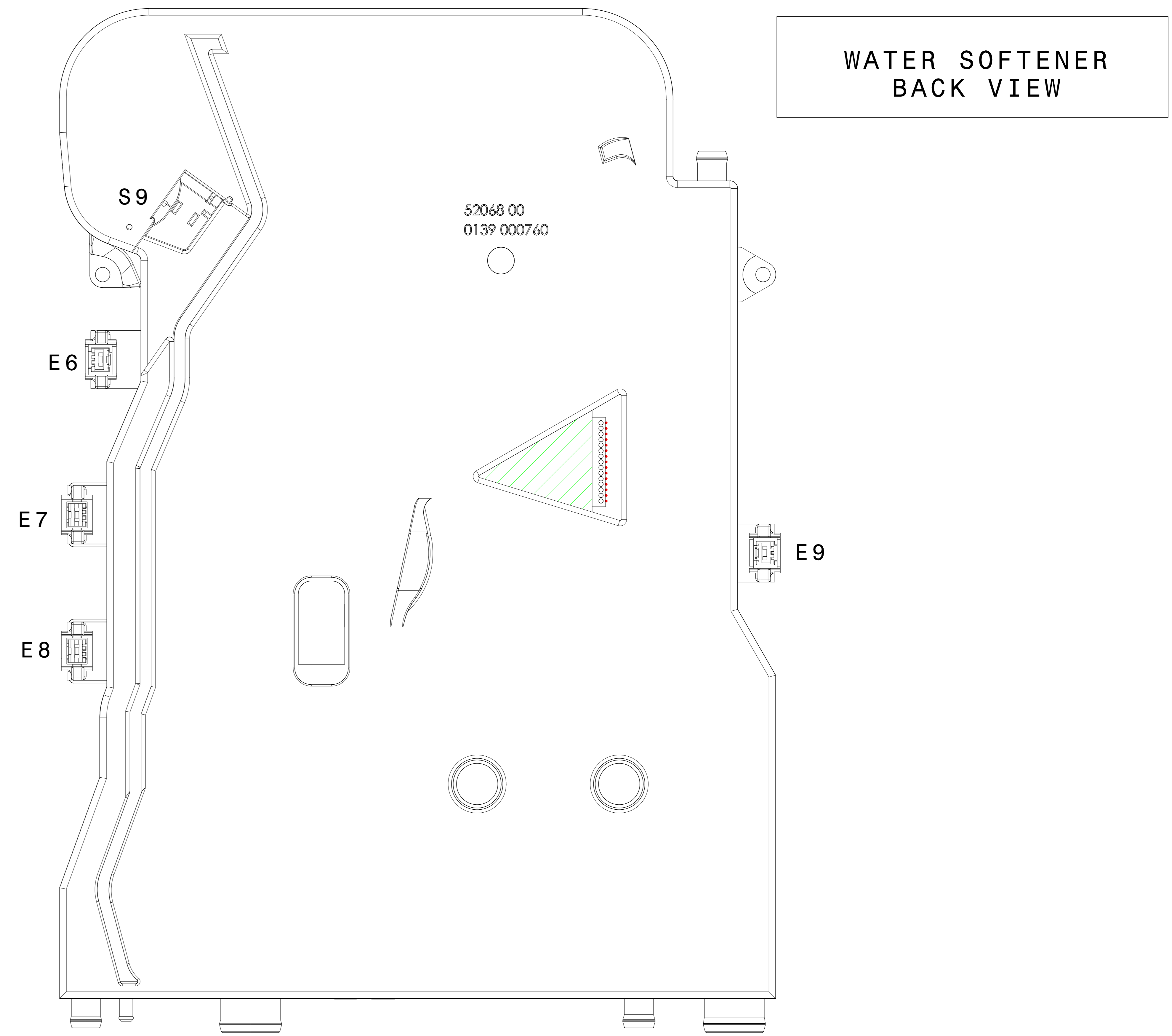
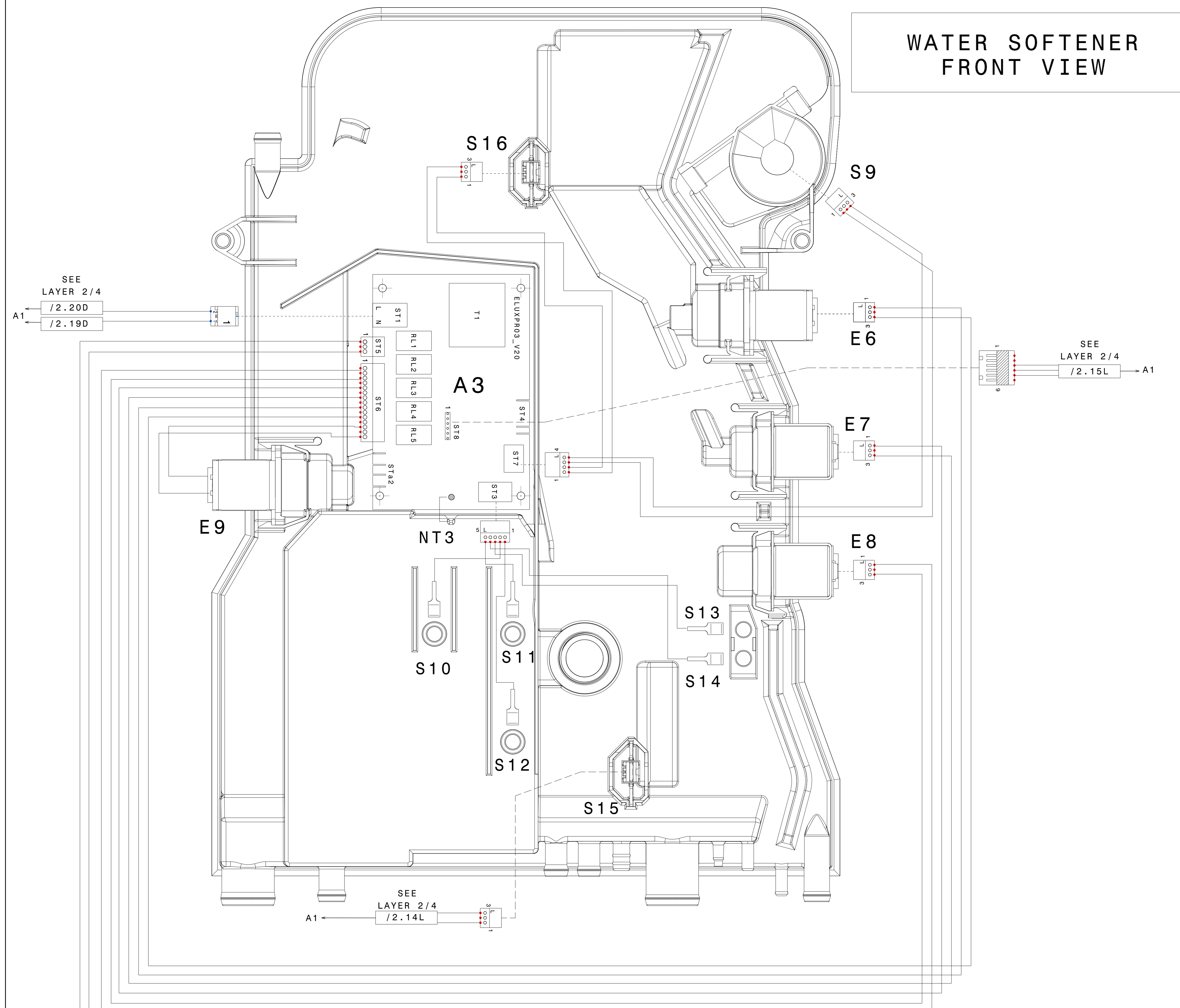

This drawing contains confidential information and is the property of
 Elettrolux Professional, Valmonesterio, Italy. Without the permission
 of Elettrolux Professional, no part of this drawing may be used
 or reproduced in any form or by any means, electronic or mechanical,
 including photocopying, recording, or by any information storage and
 retrieval system, without the prior written permission of Elettrolux
 Professional, Valmonesterio, Italy, which is responsible for the drawing.

PIEGA SU
BEND UP
PIEGA GIU
BEND DOWN

RoHS
 2011/65/EU

TI COMPONETE DEBE ESSERE
 CONFORME ALLA DIRETTIVA
 THE COMPONENT MUST BE
 COMPLIANT TO STANDARDS

| | | | | |
|------------------------------------------------------------------------------------------|--------------------------------------------------------------|------------------------------------------------------------------------------------|------------|------------------|
| K M REV | D 107 MODIFICA CONNESSIONE CAVO DI TERRA ALLA USER A2 | RAO L. BARBIERI | 19/07/2009 | PROCALE |
| | C 061 INSERITO VILVON PER PROTEZIONE RESISTENZA VASCA | RAO L. BARBIERI | 26/05/2015 | DATE |
| | 051 TOLTO FILTRO TRIFASE KI | RAO F. MORETTO | 11/04/2015 | DAV |
| | 044 MODIFICATI CONNETTORI PER LE CONNESSIONI ALLE RESISTENZE | RAO F. MORETTO | 22/12/2010 | CHP |
| | 053 MODIFICATI CONNETTORI PER LE CONNESSIONI ALLA | RAO L. BARBIERI | 04/12/2008 | CHP |
| | RESISTENZA VASCA DA TARGA A CERBIE | RAO L. BARBIERI | 04/12/2008 | CHP |
| | MODIFICAZIONE | REG. 515m | DATE | APPR. G. Moretto |
| MATERIAL: TREATMENT: SUPPLY SPECIFICATIONS N°: DERIVED FROM N°: REPLACES N°: | | | | |
| ESSERE DA NAVI E SPICCIOLI TAGLIANTI FREE OF BURRS AND CUTTING EDGES | | | | |
| Electrolux PROFESSIONAL Dishwashing | | DESCRIPTION SCHEMA ELETTRICO LS5-LS6 EUROPEAN METHOD PART N° 600625807 REV D | | |

NordCap GmbH & Co. KG
Thalendorststraße 15
28307 Bremen
Hauptsitz (Service, Finanzen & Personal, Lager, IT, Marketing)

Telefon: +49 421 48557-0
Telefax: +49 421 488650
E-Mail: bremen@nordcap.de

Die NordCap Verkaufsniederlassungen in Deutschland:

Nord: Hamburg • Ost: Berlin • Süd: Ingelheim • West: Erkrath

by **NordCap**[®]

ZANUSSI
PROFESSIONAL