

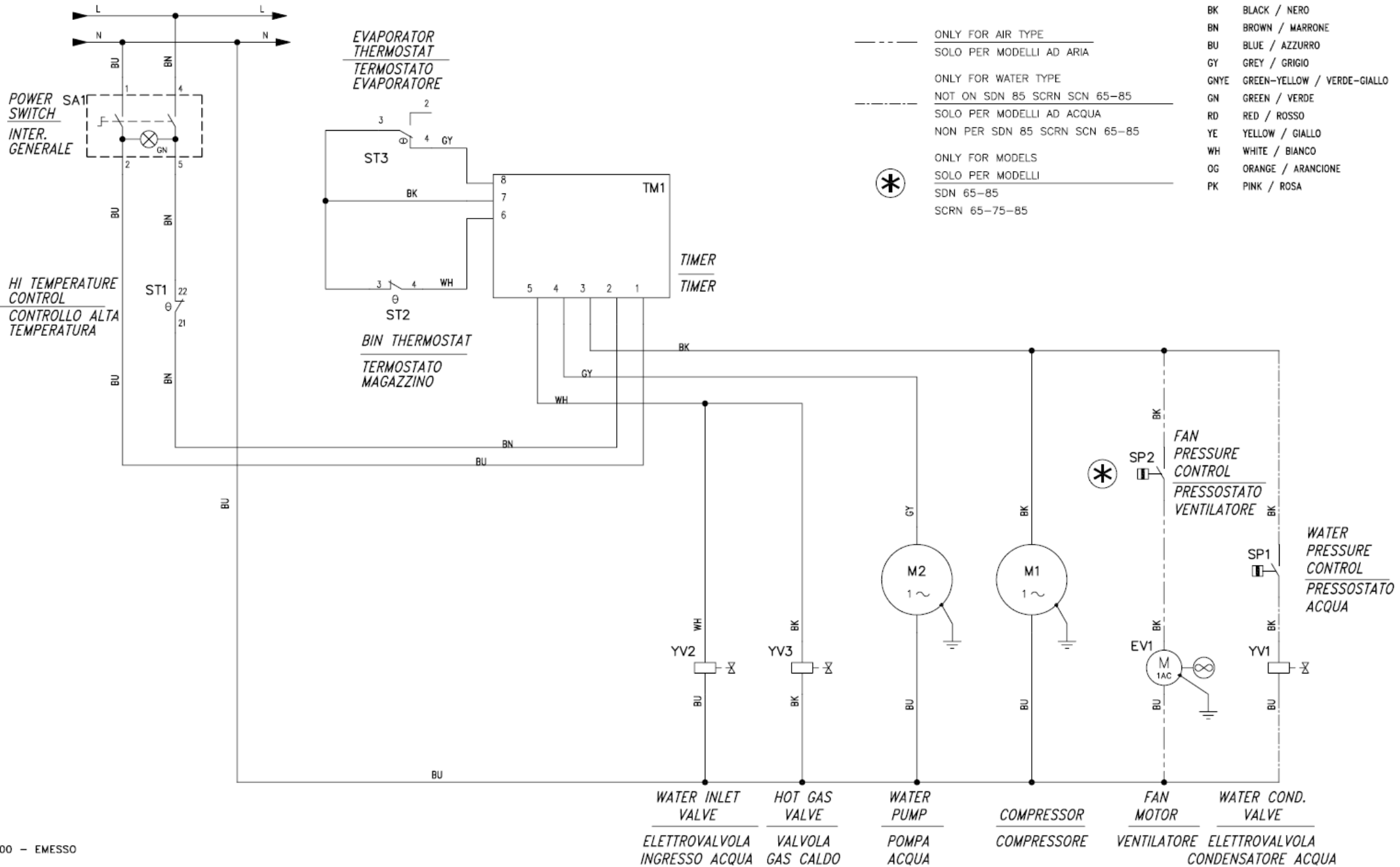















Schaltplan

Eiswürfelbereiter SDE 84 W / L





Sim.\Sym.	Sigla\Item	Funzione\Use Type
	EV1	Fan motor Ventilatore
	M1	Compressor Compressore
	M2	Water pump Pompa acqua
	M3	Pump water discharge Pompa scarico acqua
	SA2	Power switch Interruttore generale
	SK1	PWC control board Scheda controllo PWC
	SP1	Pressure water control Pressostato acqua
	SP2	Fan pressure control Pressostato ventilatore
	ST1	HI Temperature control Controllo alta temperatura
	ST2	Bin thermostat Termostato magazzino
	ST3	Evaporator thermostat Termostato evaporatore

Sim.\Sym.	Sigla\Item	Funzione\Use Type
	TM1	Electronic timer Timer elettronico
	WS1	Water level sensor Sensore livello acqua
	YV1	Water condenser valve Elettrovalvola condensatore acqua
	YV2	Water inlet valve Elettrovalvola ingresso acqua
	YV3	Hot gas valve Elettrovalvola gas caldo

- BK BLACK
- BN BROWN
- BU BLUE
- GY GREY
- GNYE GREEN-YELLOW
- GN GREEN
- RD RED
- YE YELLOW
- WH WHITE
- OG ORANGE
- PK PINK

Finanzen/Service
28307 Bremen
Thalenhorststraße 15
Tel.+49 421 48557-0
Fax+49 421 488650
bremen@nordcap.de

Vertrieb Ost
12681 Berlin
Wolfener Straße 32/34, Haus K
Tel.+49 30 936684-0
Fax+49 30 936684-44
berlin@nordcap.de

Vertrieb West
40699 Erkrath
Max-Planck-Straße 30
Tel.+49 211 540054-0
Fax+49 211 540054-54
erkrath@nordcap.de

Vertrieb Nord
21079 Hamburg
Großmoorbogen 5
Tel.+49 40 766183-0
Fax+49 40 770799
hamburg@nordcap.de

Vertrieb Süd
55218 Ingelheim
Hermann-Bopp-Straße 4
Tel.+49 6132 7101-0
Fax+49 6132 7101-20
ingelheim@nordcap.de



www.nordcap.de