

Schaltplan

Elektro-Fritteuse EF7 / 1B7LT

[Artikel-Nr.: 406372075]

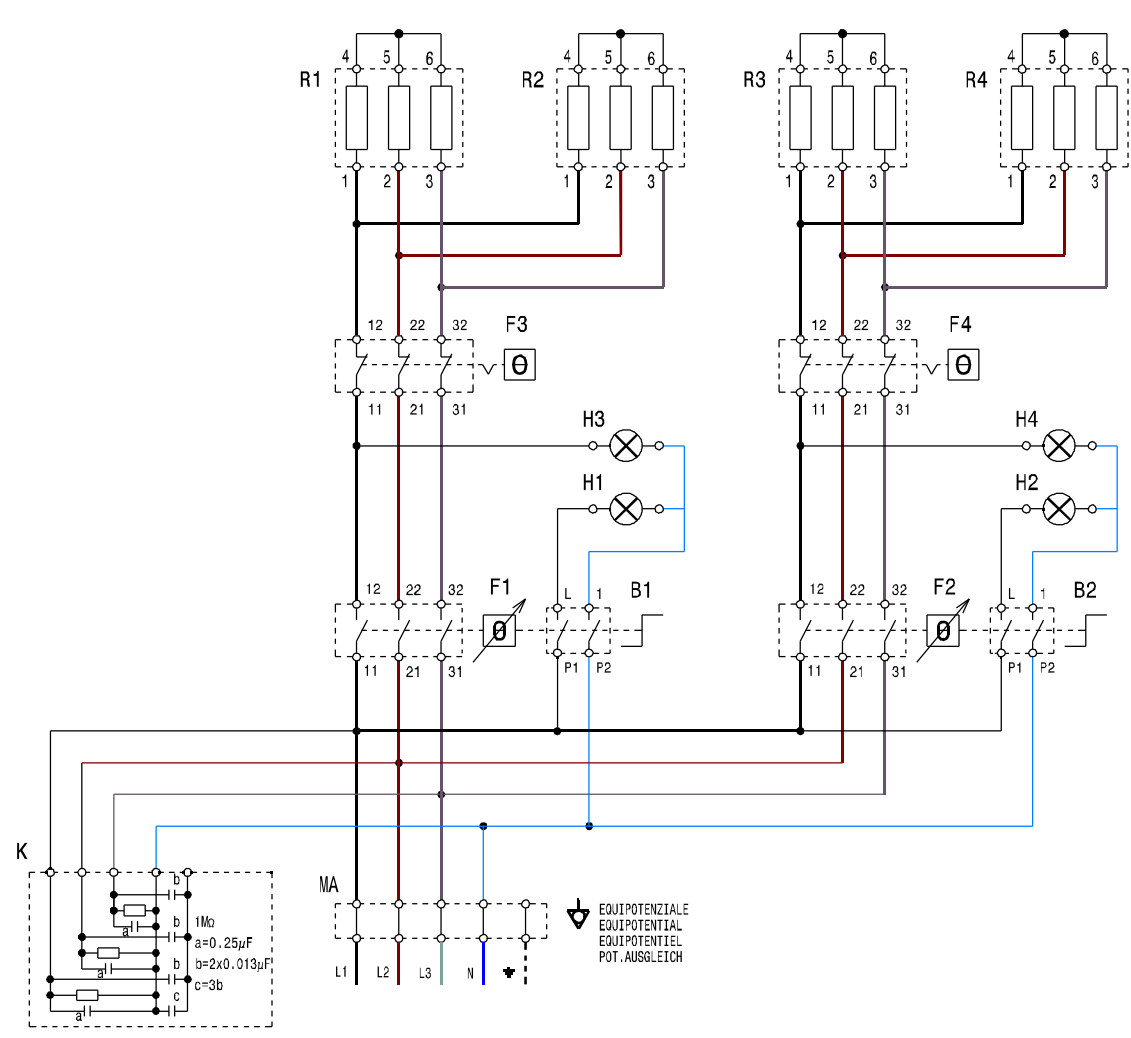

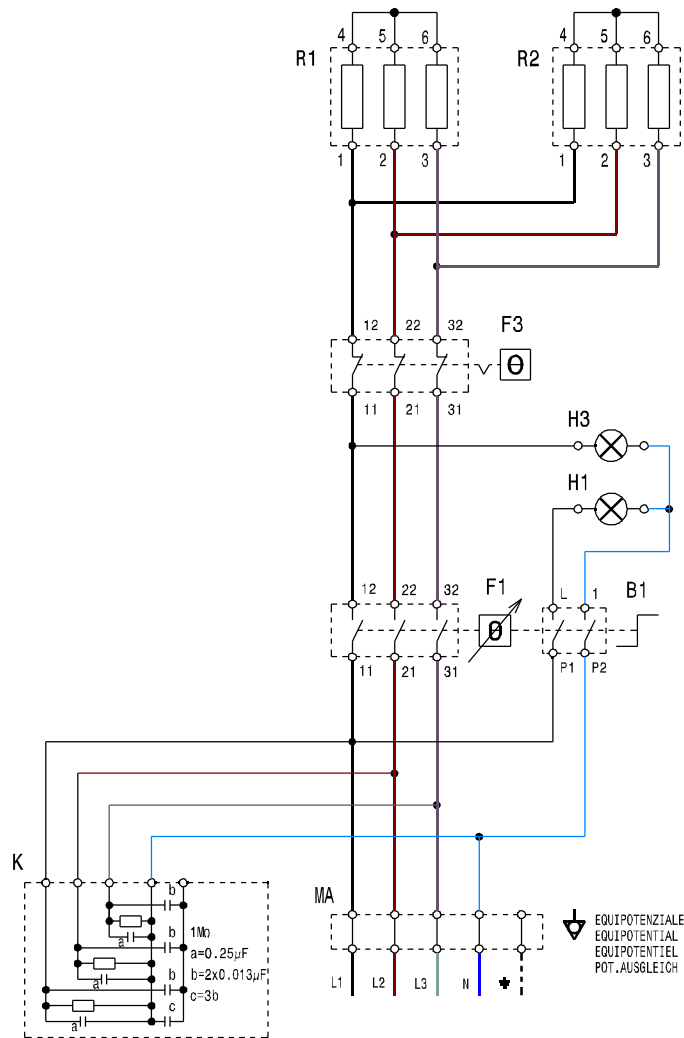

FRIGGITRICE 7LT XP700
 FRYER 7LT XP700
 380-400V 3N ~ 50/60Hz
 5,4 kW 8A (400V)

FRIGGITRICE 2x7LT XP700
 FRYER 2x7LT XP700
 380-400V 3N ~ 50/60Hz
 10,8 kW 16A (400V)

RICAVARE I DATI DI ALIMENTAZIONE DELL'APPARECCHIATURA DALL'ETICHETTA DATI TARGA
 FOR APPLIACE POWER SUPPLY VALUES, REFER TO DATA LABEL

R1-4	RESISTENZA	HEATING ELEMENT
F3-F4	LIMITATORE DI TEMPERATURA	SAFETY THERMOSTAT
H3-H4	LAMPADA TERMOSTATO	THERMOSTAT LAMP
H1-H2	LAMPADA PRESENZA TENSIONE	POWER ON LAMP
B1-B2	INTERRUTTORE GENERALE	MAIN SWITCH
F1-F2	REGOLATORE DI TEMPERATURA	TEMPERATURE REGULATOR
K	FILTRO RADIODISTURBI	RADIO INTERFERENCE FILTER
MA	MORSETTIERA	MAIN TERMINAL BOARD

Finanzen/Service

28307 Bremen
Thalenhorststraße 15
Tel.+49 421 48557-0
Fax+49 421 488650
bremen@nordcap.de

Vertrieb Ost

12681 Berlin
Wolfener Straße 32/34, Haus K
Tel.+49 30 936684-0
Fax+49 30 936684-44
berlin@nordcap.de

Vertrieb West

40699 Erkrath
Max-Planck-Straße 30
Tel.+49 211 540054-0
Fax+49 211 540054-54
erkrath@nordcap.de

Vertrieb Nord

21079 Hamburg
Großmoorbogen 5
Tel.+49 40 766183-0
Fax+49 40 770799
hamburg@nordcap.de

Vertrieb Süd

55218 Ingelheim
Hermann-Bopp-Straße 4
Tel.+49 6132 7101-0
Fax+49 6132 7101-20
ingelheim@nordcap.de



www.nordcap.de